

TO RELEASE ARM FOR RETRACTION OF WHEELS REMOVE PIN AND MOVE SLIDE FORWARD.

DETAIL "A"
SCALE: 3" = 1'-0"

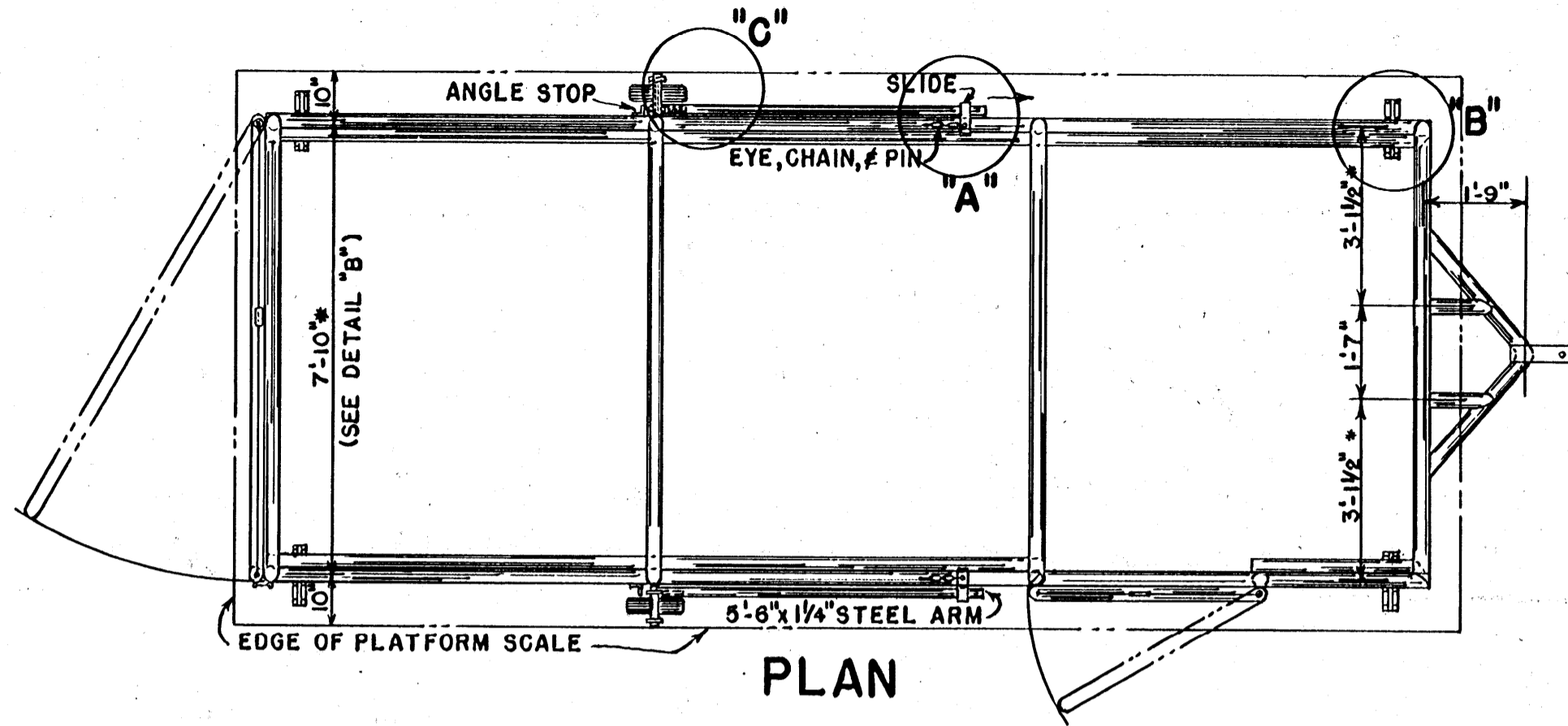

PLAN

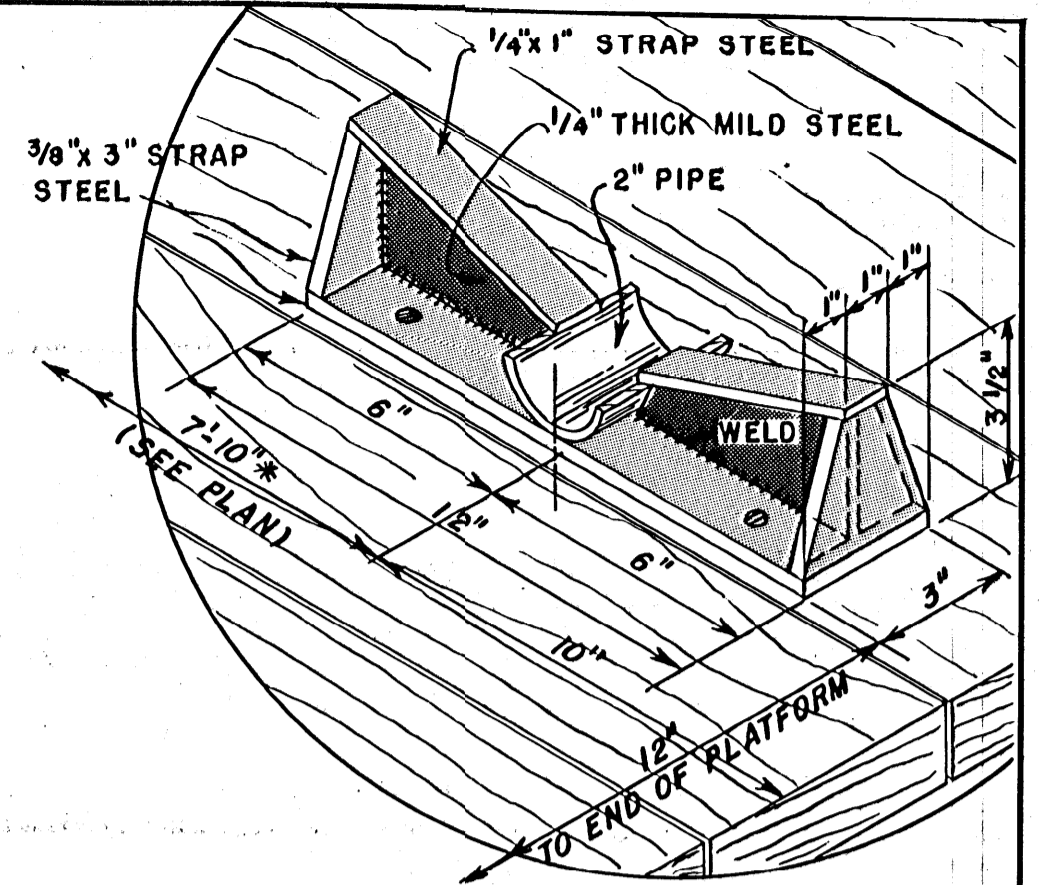

DETAIL "B"
SCALE: 3" = 1'-0"

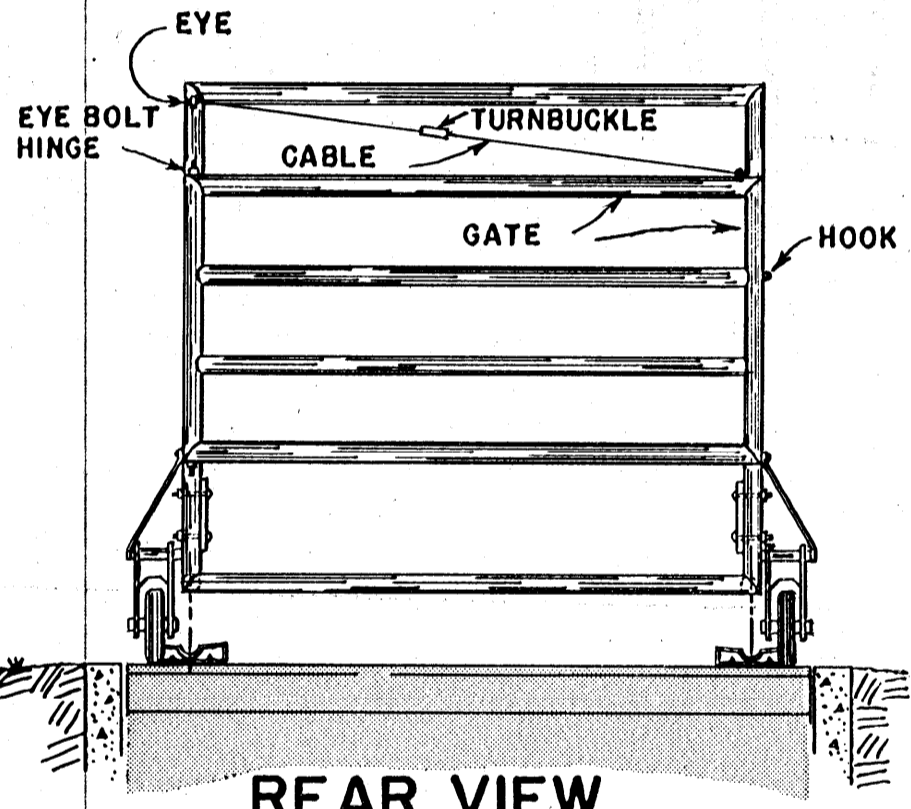

REAR VIEW

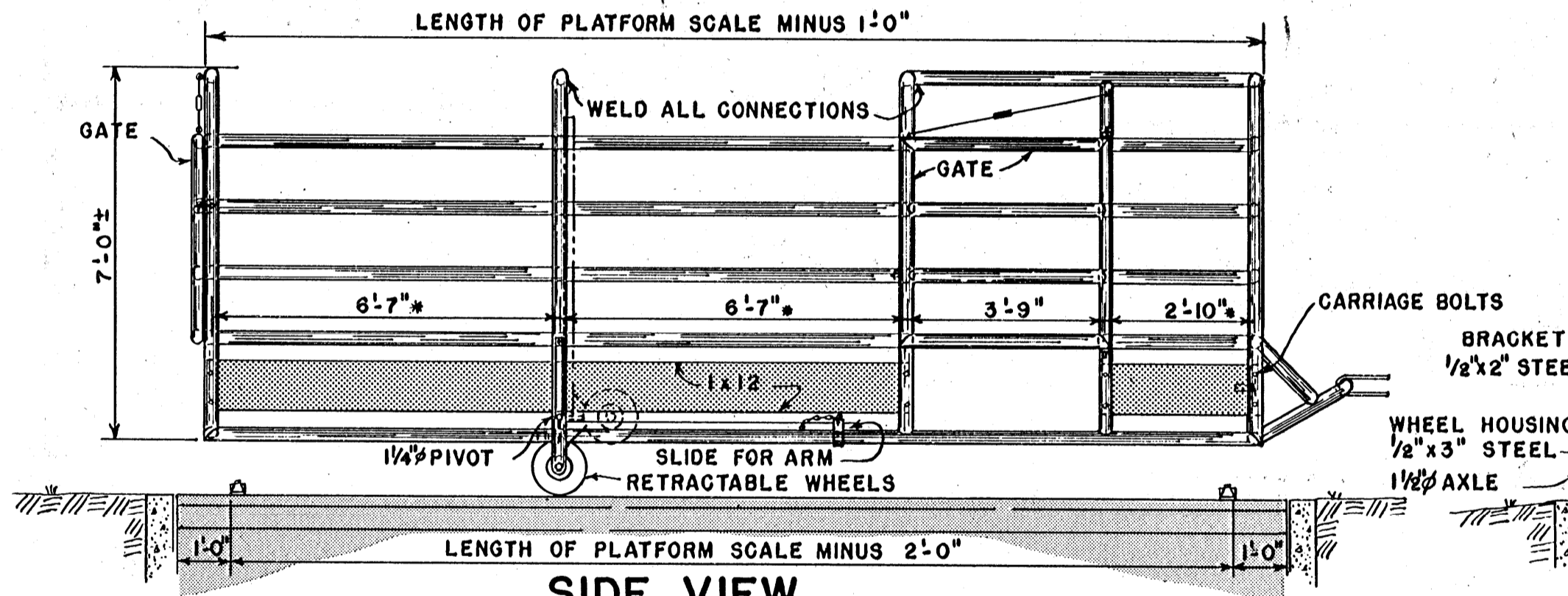

SIDE VIEW

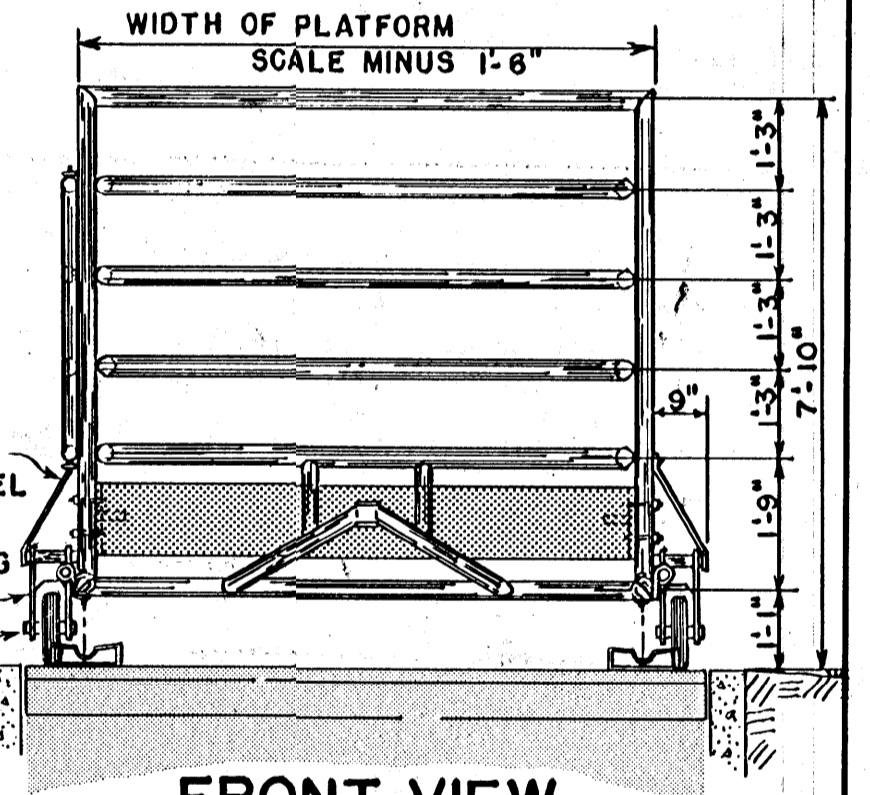

FRONT VIEW

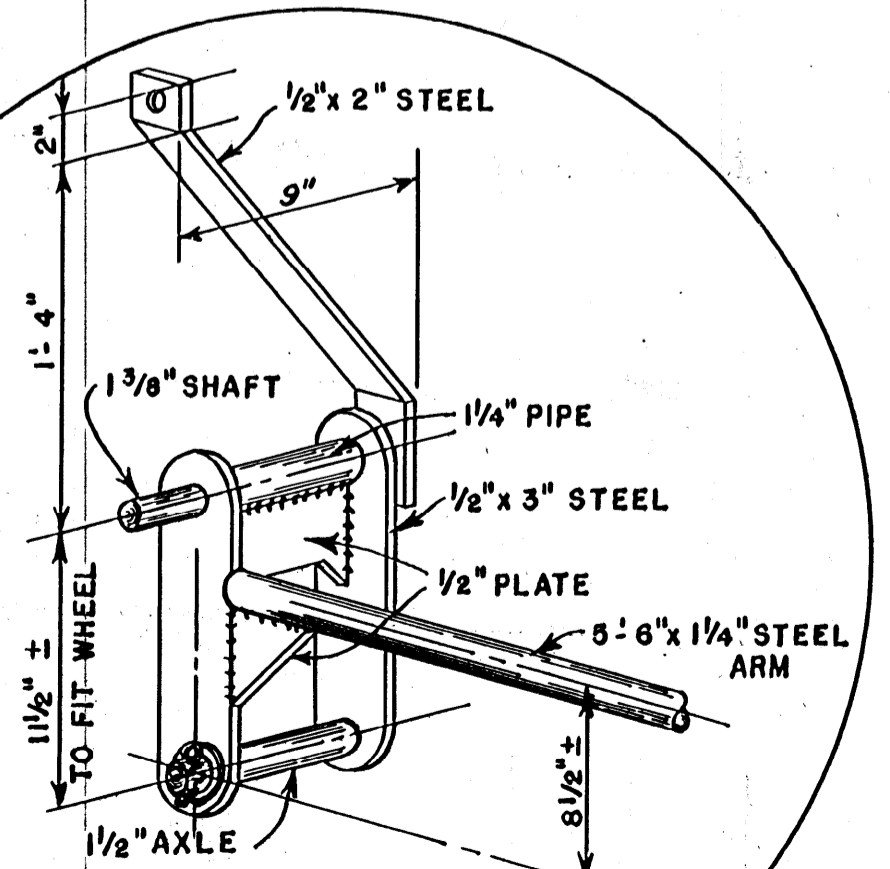

DETAIL "C"
SCALE: 1 1/2" = 1'-0"

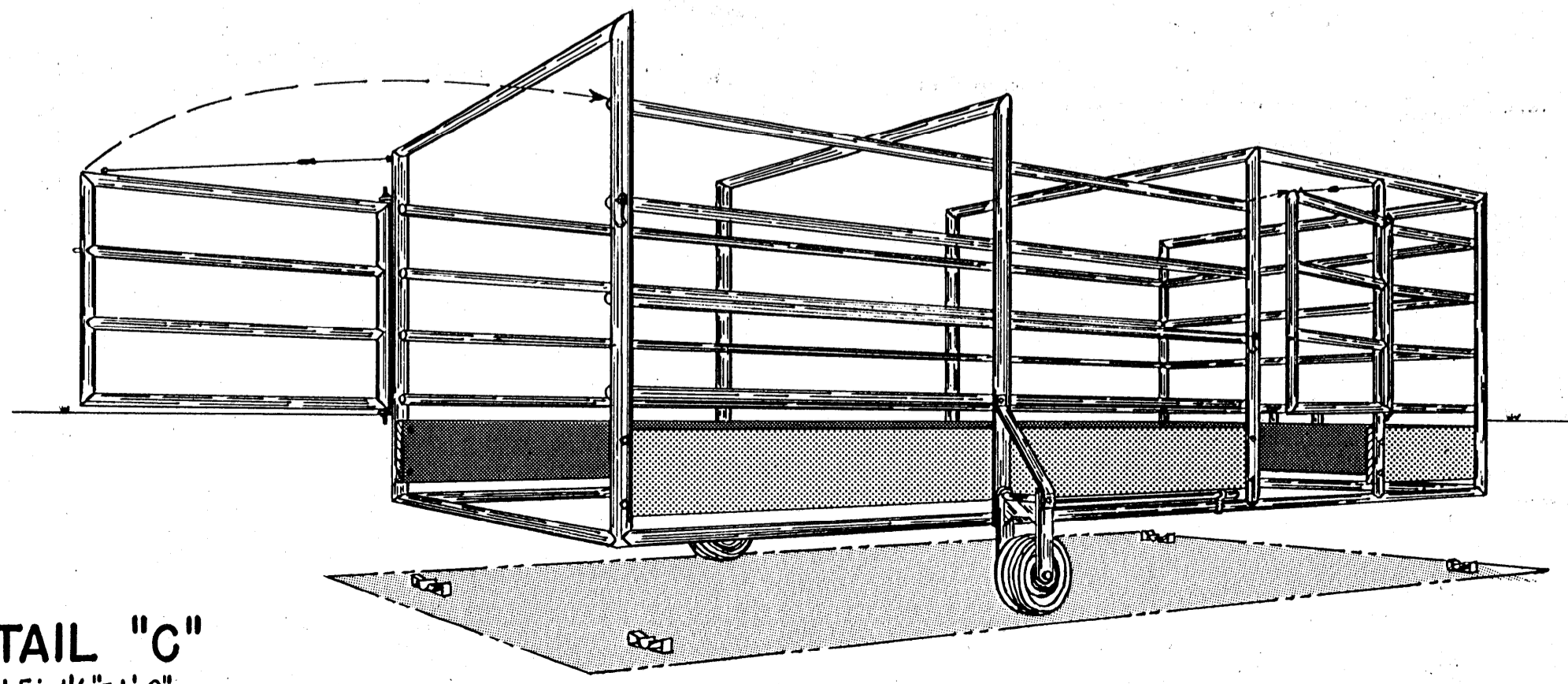

NOTES:

- 1 ALL CONSTRUCTION TO BE 1 1/4" PIPE.
- WELDED CONNECTIONS THRU-OUT.
- * DIMENSIONS VARIABLE, BASED ON SIZE PLATFORM SCALE USED.

BASED ON MONTANA PLAN NO. 64

SCALE: 3/8" = 1'-0" UNLESS OTHERWISE NOTED
 COOPERATIVE EXTENSION WORK IN
 AGRICULTURE AND HOME ECONOMICS
 STATE OF MISSISSIPPI
 MISSISSIPPI STATE UNIVERSITY
 AND
 UNITED STATES DEPARTMENT OF AGRICULTURE COOPERATING

MOVABLE PEN		
FOR TRUCK PLATFORM SCALE		
USDA '61	EX. 5932	SHEET 1 OF 1