

PLAN VIEW — BARN FOR WAGON FEEDING  
HEIFERS ONLY — SECTION FOR DRY COWS OPTIONAL

SCALE: 1/8"=1'-0"

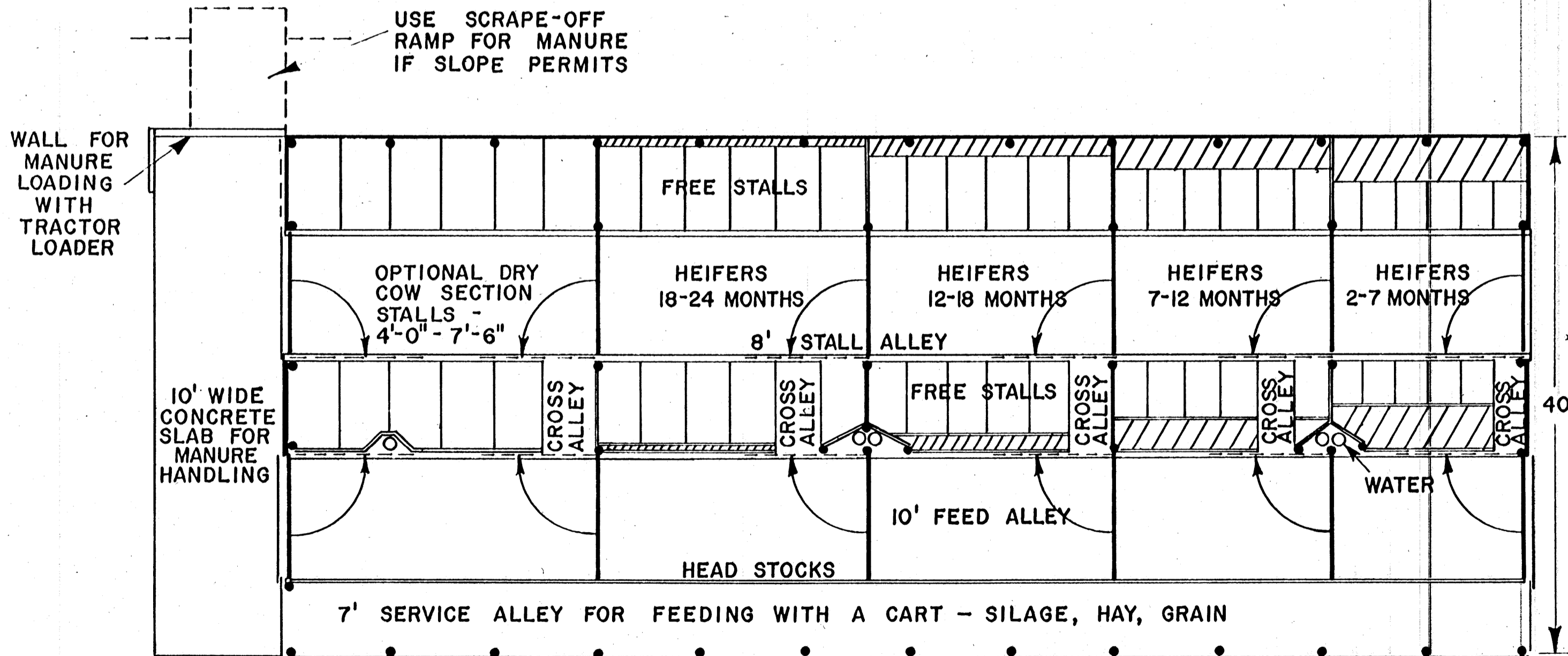

PLAN VIEW — BARN FOR HEIFERS AND DRY COWS  
CLOSED SIDES IF DESIRED — USE FOR CART FEEDING

SCALE: 1/8"=1'-0"

TWO VERSIONS OF THE FREE STALL BARN ARE SHOWN, CAN BE OPEN ON ONE SIDE OR CLOSED AS A COLD, COVERED SYSTEM.

PENN. STATE UNIV. PLAN NO. 723-202

COOPERATIVE EXTENSION WORK IN AGRICULTURE AND HOME ECONOMICS  
STATE OF MISSISSIPPI  
MISSISSIPPI STATE UNIVERSITY  
AND UNITED STATES DEPARTMENT OF AGRICULTURE COOPERATING

HEIFER BARN  
FREE STALL

PENN. '70- 6102 SHEET 1 OF 4

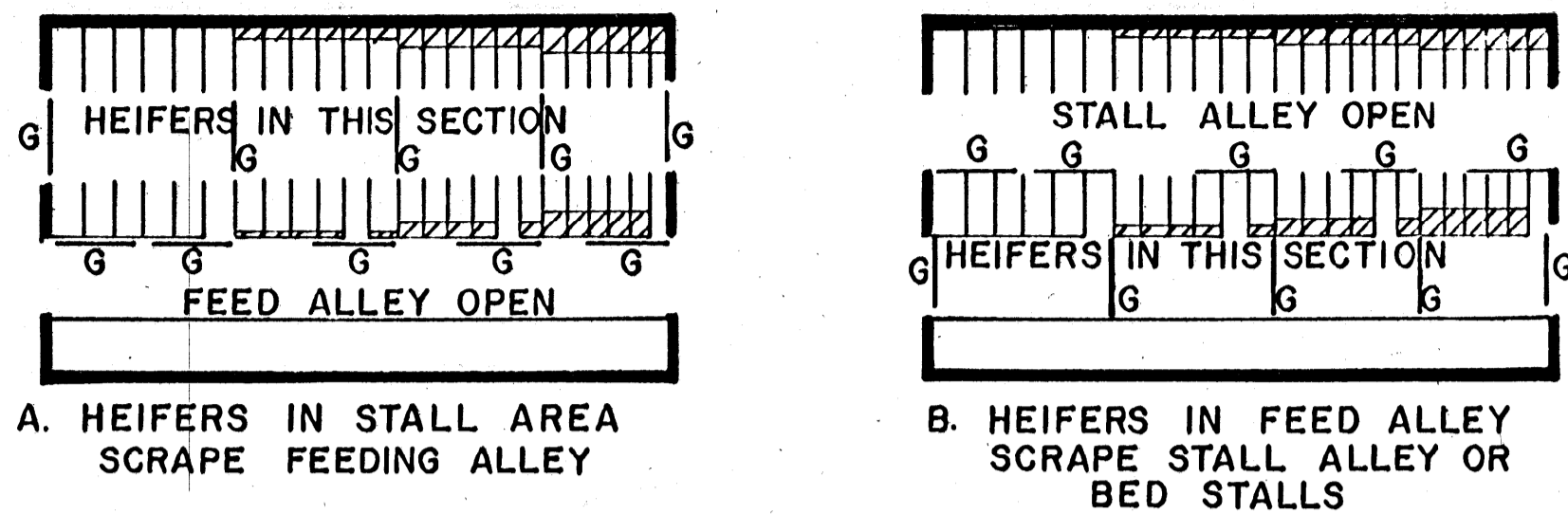

FIG. 1 - HOW THE GATE SYSTEM WORKS FOR CLEANING

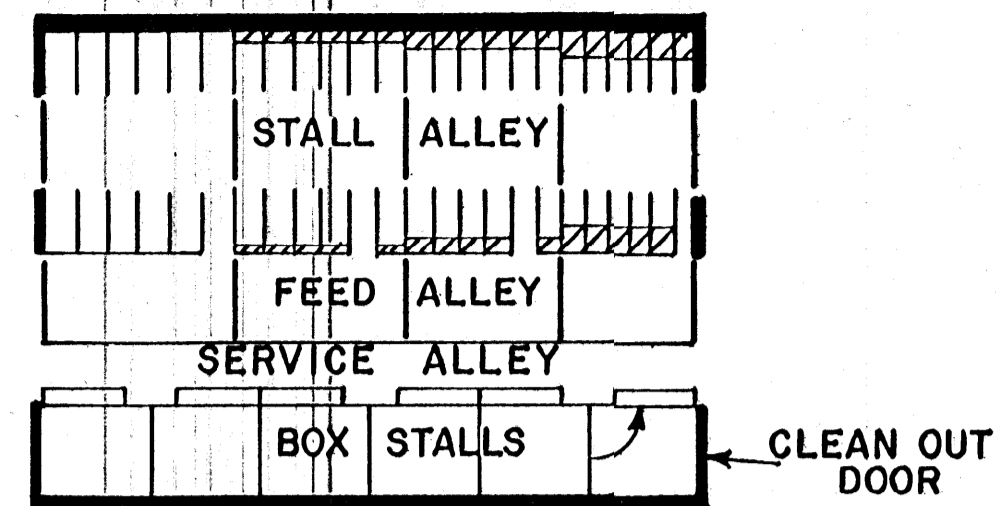

FIG. 2 - BARN 52' WIDE WITH BOX STALLS

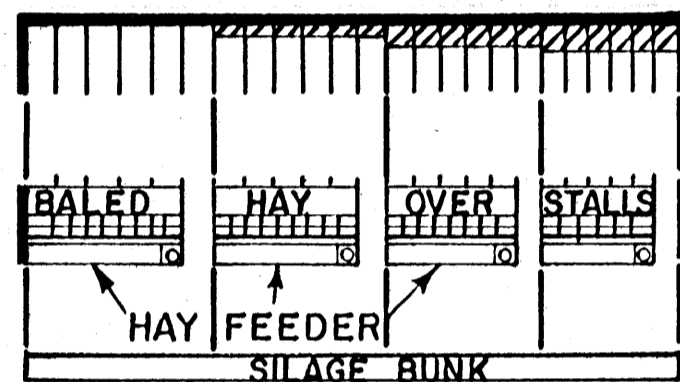

FIG. 3 - BARN WITH HAY FEEDER,  
HAY STORAGE OVER STALLS

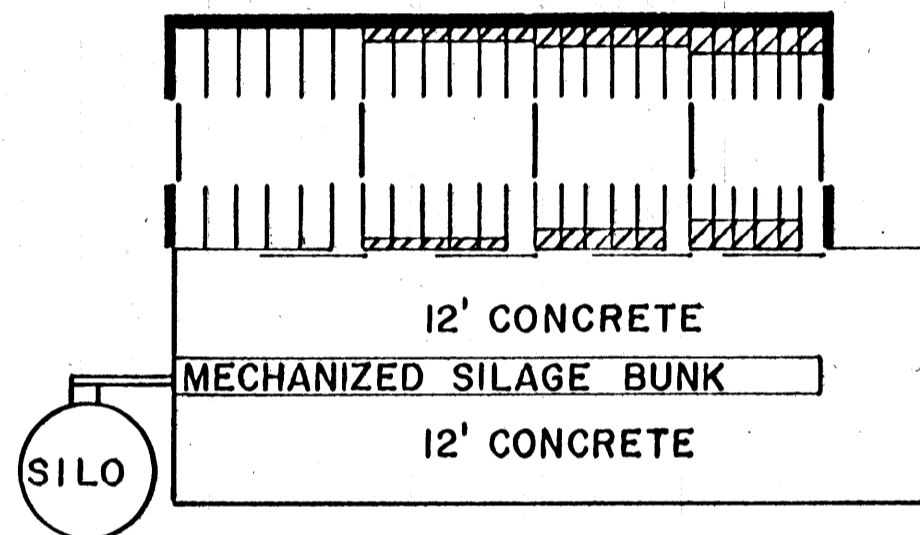

FIG. 4 - BARN WITH SILO AND BUNK,  
COWS FEED, HEIFERS SHUT IN STALL ALLEY

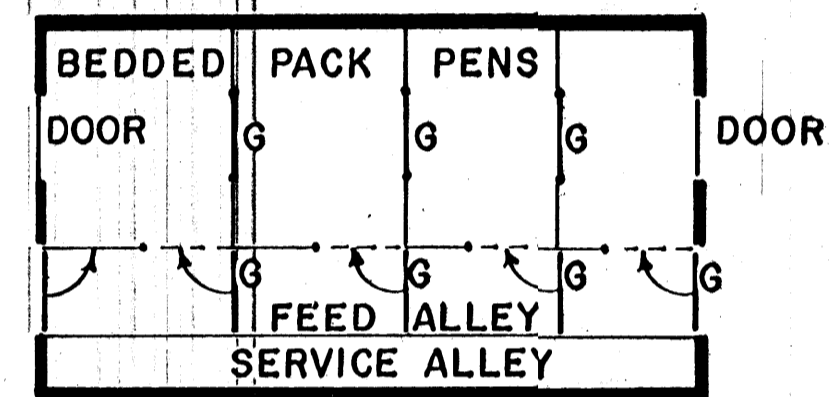

FIG. 5 - BARN FOR BEDDED PENS,  
CAN ADD FREE STALLS LATER

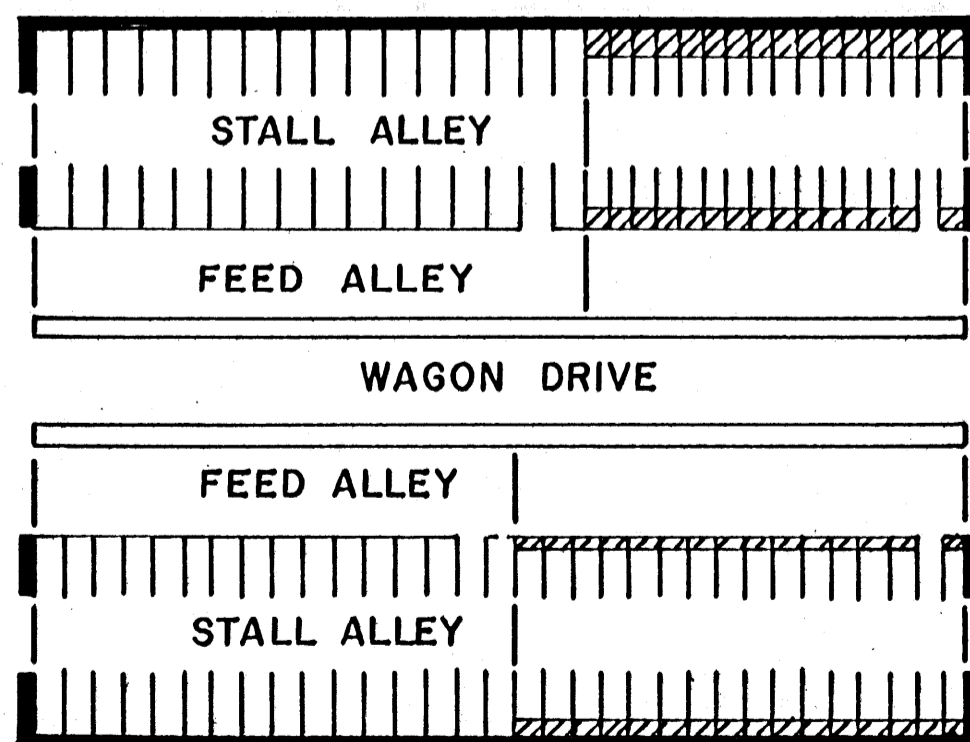

FIG. 6 - DOUBLE BARN FOR LARGE OPERATION

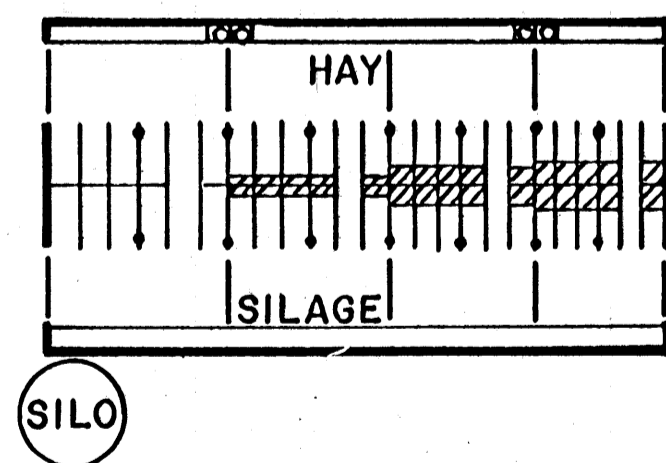

FIG. 7 - REMODELED STALL BARN  
FOR GATED FREE STALL HEIFER BARN

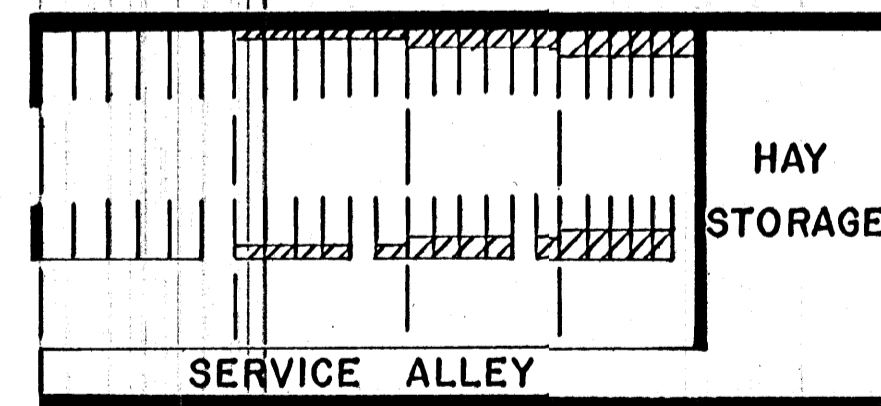
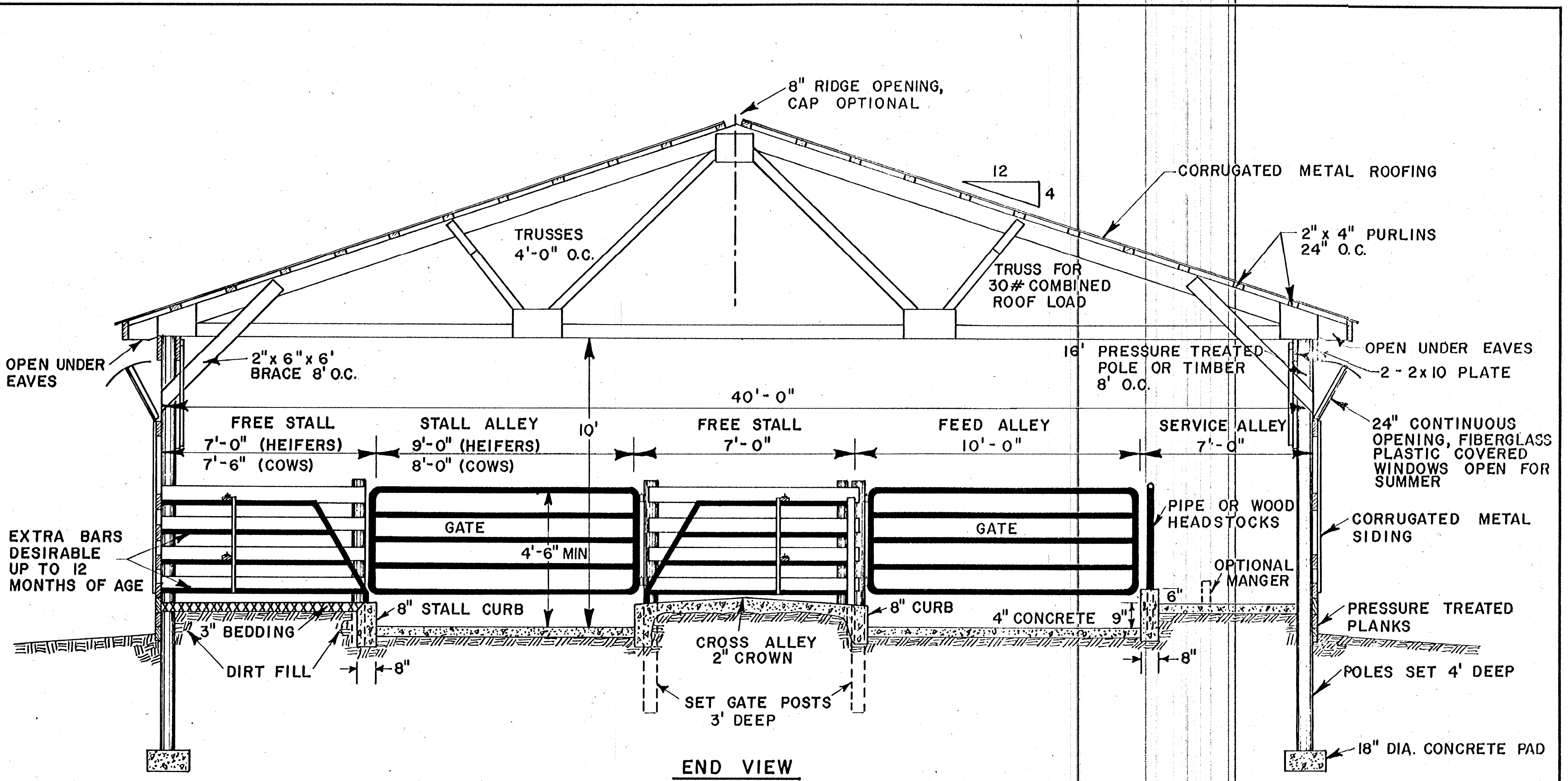

FIG. 8 - HAY STORAGE AT END



AGE IN MONTHS	WEIGHT POUNDS	FREE STALL SIZES	NUMBER OF STALLS PER SECTION								
			5+4	6+5	7+6	8+7	9+8	10+9	11+10	12+11	13+12
2 - 7	to 450	2'-6" x 4'-6"	12'-6"	15'-0"	17'-6"	20'-0"	22'-6"	25'-0"	27'-6"	30'-0"	32'-6"
7 - 12	to 650	2'-10" x 5'-0"	14'-2"	17'-0"	19'-10"	22'-6"	25'-6"	28'-4"	31'-2"	34'-0"	36'-10"
12 - 18	to 875	3'-2" x 6'-0"	15'-10"	19'-0"	22'-2"	25'-4"	28'-6"	31'-8"	34'-10"	38'-0"	41'-2"
18 - 24	to 1150	3'-6" x 7'-0"	17'-6"	21'-0"	24'-6"	28'-0"	31'-6"	35'-0"	38'-6"	42'-0"	45'-6"
LENGTH OF BARN			60'-0"	72'-0"	84'-0"	96'-0"	108'-0"	120'-0"	132'-0"	144'-0"	156'-0"
NUMBER OF HEIFERS			36	44	52	60	68	76	84	92	100

LENGTH NEEDED FOR VARIOUS NUMBERS OF HEIFERS - IF DRY COWS ARE INCLUDED, USE MULTIPLES OF 4 FEET (STALLS 4'-0" x 7'-6")

COOPERATIVE EXTENSION WORK IN AGRICULTURE AND HOME ECONOMICS  
 STATE OF MISSISSIPPI  
 MISSISSIPPI STATE UNIVERSITY  
 AND  
 UNITED STATES DEPARTMENT OF AGRICULTURE COOPERATING

**HEIFER BARN  
 FREE STALL**

PENN. '70	6102	SHEET 3 OF 4
-----------	------	--------------

SEE SHEET 3 FOR LENGTHS OF HEIFER SECTIONS

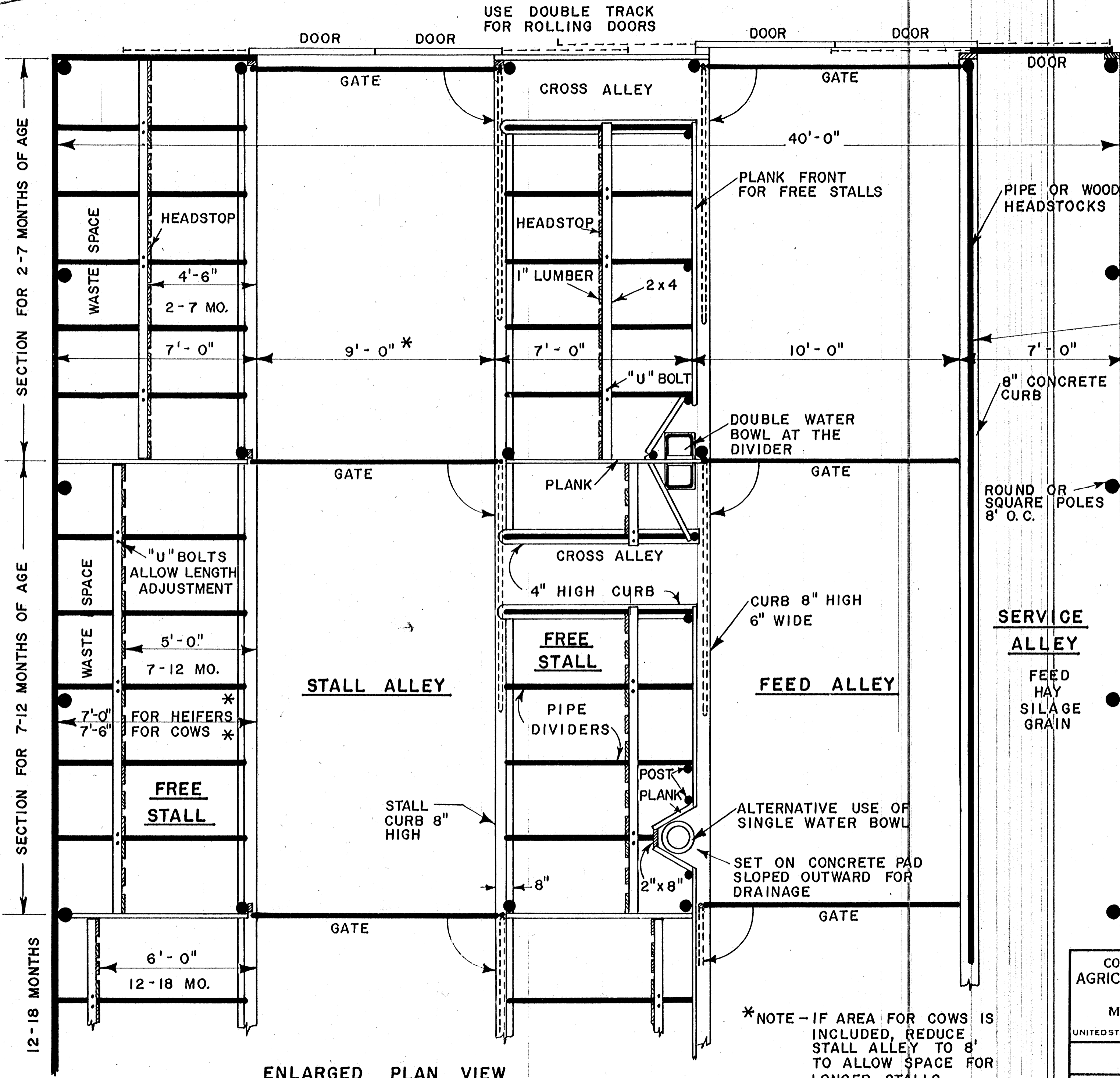

HEADSTOCK OPENINGS

2-7 MONTHS	- 7"
7-12 MONTHS	- 8 1/2"
12-18 MONTHS	- 10"
18-24 MONTHS	- 11"
COWS	12"

LEVER OPERATED STANCHIONS MAY BE USED IF DESIRED

\*NOTE - IF AREA FOR COWS IS INCLUDED, REDUCE STALL ALLEY TO 8' TO ALLOW SPACE FOR LONGER STALLS.

ENLARGED PLAN VIEW  
SCALE: 3/8" = 1'-0"

COOPERATIVE EXTENSION WORK IN AGRICULTURE AND HOME ECONOMICS  
STATE OF MISSISSIPPI  
MISSISSIPPI STATE UNIVERSITY  
AND  
UNITED STATES DEPARTMENT OF AGRICULTURE COOPERATING

**HEIFER BARN  
FREE STALL**

PENN. '70	6102	SHEET 4 OF 4
-----------	------	--------------